

BASICS

A few simple tools are required:

- Measuring tape
- Power drill, drill bits
- Hex head and/or Phillips driver bit
- Pencil

Additional fasteners other than those sent with your shade may be required depending on the mounting surface. Wallboard and plaster require the use of anchors such as expansion or toggle bolts. Brick, tile or stone need special plugs and drill bits. Remember to always pre-drill holes in wood to avoid splitting.

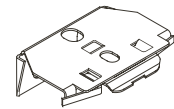

Mounting Bracket



Installation Screw
(2 per Bracket)

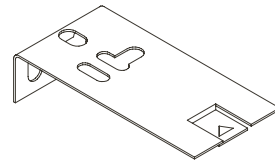

Valance Bracket

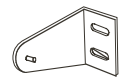

Hold Down Bracket
(optional)



Bracket Attachment Screw

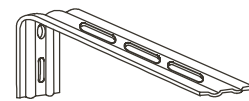

Extension Bracket
(optional)

BRACKET INSTALLATION

Shade Width	# of Brackets
Up to 40"	2
>40" to 72"	3
>72" to 84"	4
>84" and up	5*

End brackets should be located with centerlines 2 1/2" in from each end.

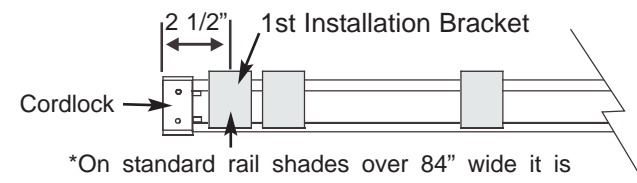

*On standard rail shades over 84" wide it is recommended to use a second bracket located next to the end bracket at the Cord Lock.

Depending on the width of the shade, additional brackets may be necessary evenly spaced between the two end brackets.

Using the Installation Bracket as a template, measure and mark the center lines. When mounting brackets, make sure they are in line and level.

INSIDE MOUNT

The brackets are mounted flat against the top sill surface.

To mount a flush headrail requires a flat surface with a minimum depth of 1 7/8".

To fully recess a shade with the valance, requires a flat surface with a minimum depth of 3".

Shallow mounting requires 3/4" minimum.

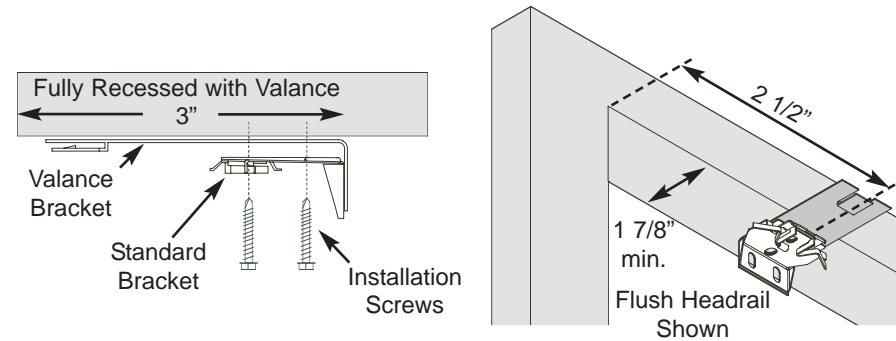

OUTSIDE MOUNT

The brackets are mounted with two screws through the back end of the bracket flat against the window molding or the wall above the window. The bracket requires a minimum surface 3/4" high.

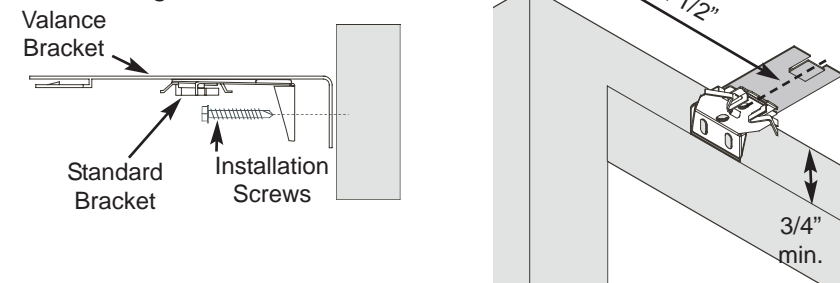

EXTENSION BRACKETS (Optional)

Optional Extension Brackets are used to project the back of the shade up to 3" from the mounting surface. Attach the Installation Bracket to the Extension Bracket with the nut and bolt provided.

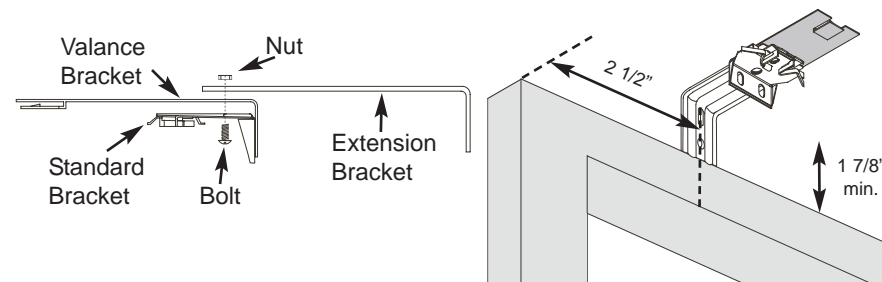

HANGING THE SHADE

1. Hold the shade up near the brackets and insert the front clip of the bracket into the front groove of the rail.
2. Make sure the shade is centered in the window opening.
3. Push the rail back and up until the back clips of the bracket are inserted in the back groove of the rail.

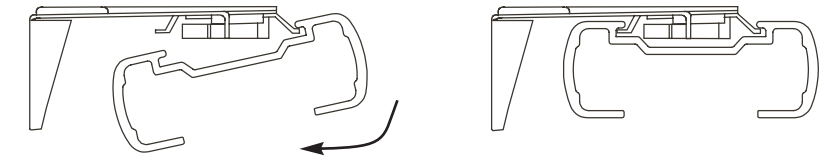

To remove shade, reverse procedure.

INSTALLING THE VALANCE

Align the valance with the Valance Brackets. Gently push at each bracket location until the valance is fully seated.

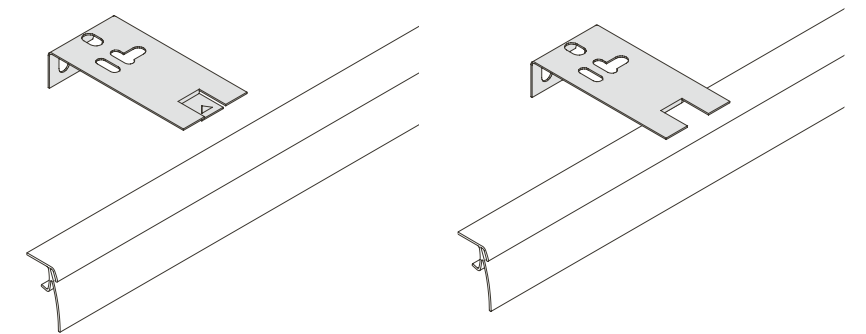

CORDLOCK OPERATION

To lower or release shade, pull the cord inward toward the center of the shade.

To raise or lock the shade, pull the cord straight down and outward toward the edge of the shade.

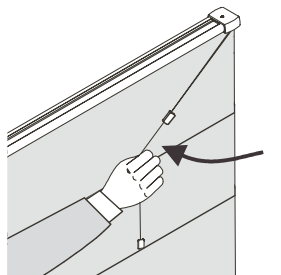

PROTECT YOUR CHILDREN

Be aware that it is possible for children to strangle in window covering cords. To reduce the occurrence of accident, all cords must be kept out of the reach of children, including infants. Cord cleats are an effective way to implement this essential precaution.

Mount the cord cleat at a safe height, taking into account furniture or other objects upon which a child may climb. Then, after each use of the shade, simply wrap the excess cord around the cleat. It's fast, easy and safe.

To protect your children, we are pleased to provide cord cleats free of charge upon request.



HOLD DOWN BRACKET (Optional)

Optional Hold Down Brackets are mounted with the supplied screws. With the shade at its proper drop, place the pin of each Hold Down into the hole in each End Cap and mark the screw holes. Make sure the pins are level and aligned. Raise the shade, then screw the Hold Down Bracket into the mounting surface.

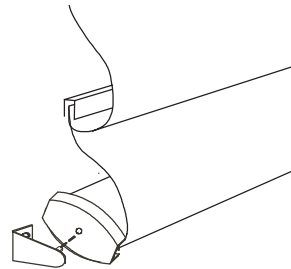

CLEANING AND CARE

The shades are as easy to clean as they are to operate. Roman fabrics are anti-static and actually repel dust. Occasional vacuuming with a soft bristle attachment is all that is needed. Also the use of a feather duster or dust buster at a low setting will help keep your shades clean and fresh. Roman shades may also be cleaned ultrasonically.

Installation Instructions for Standard Roman Shades

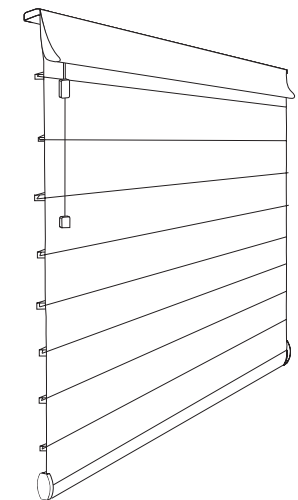
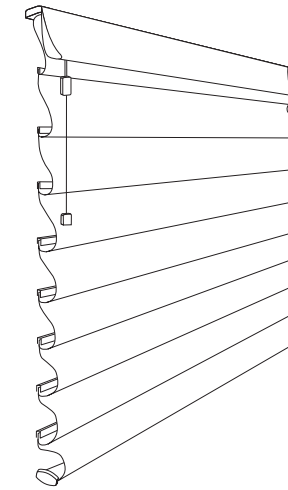

Our window fashions represent a design breakthrough in style, efficiency and function. The unique hardware system is designed to provide years of reliable service when properly installed.

Please take a few minutes to read through these instructions before beginning.